

IONIC®

ADVANCED FLEXIBLE SOLUTIONS

OFFICE

*IONIC designs, manufactures and distributes innovative advanced flexible solutions for LCD and Plasma screens. Our range consists out of high-end mounting brackets, flexible cable management and storage possibilities for peripherals. Top design and functionality are binding assets of our products.*

**Our mission** is to improve space around LCD and plasma televisions and workstations by adding design and comfort. Targeted end-users use our products in their residential houses, but also see them in offices, retail and service providers, all over the world.

**IONIC** focuses on design, innovation and marketing. Production and logistics are outsourced. In this way the beginning of the product chain, the birth of a product, gets our full attention. All aspects will be considered and not even a small detail will be forgotten.

**IONIC** is an international oriented company, its production takes place in China. Customers will be serviced from warehouses in Panyue in China, Nieuwegein in The Netherlands and Zeeland (Michigan) in the USA.

**IONIC** products have outstanding design; function better as competitive products and are still being sold at equal prices. Together with our high standard after-sales procedure and reliable delivery performances, we offer the pure basis for a good relationship.

**Our client** is put on top of the scheme. This means we will do our utmost to satisfy the client. Our product has to be of high quality as well as our service towards clients.

#### **IONIC BV**

GELDERLANDHAVEN 2T  
NL-3433 PG NIEUWEGEIN  
INTERNET [WWW.IONIC.NL](http://WWW.IONIC.NL)  
PHONE +31 (0)30 600 61 00

# OFFICE ZOOM 100



# OFFICE ZOOM 100



25KG



75&100

- Adjustable height . . . . . 30 to 42 cm
- Turning . . . . . 30°
- Tilting . . . . . 15° up & 15° down
- Rotating . . . . . 360°
- Execution . . . . . Gas-spring (GS)
- . . . . . Standard (SR)

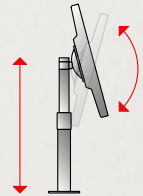

SIDEVIEW

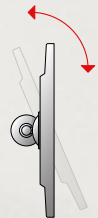

TOPVIEW

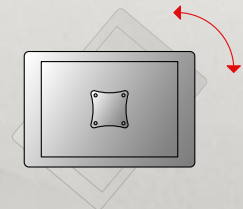

FRONTVIEW

OFFICE ZOOM 101



# OFFICE ZOOM 101



18KG



75&100

- Adjustable height . . . . . 30 to 42 cm
- Extension . . . . . 25 cm
- Rotating . . . . . 360°
- Tilting . . . . . 15° up & 15° down
- Swivel . . . . . 95°
- Execution . . . . . Gas-spring (GS)
- . . . . . Standard (SR)

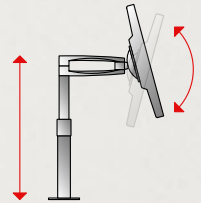

SIDEVIEW

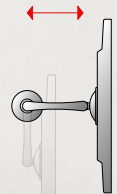

TOPVIEW

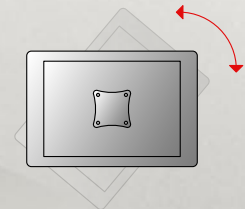

FRONTVIEW

# OFFICE ZOOM 102



# OFFICE ZOOM 102

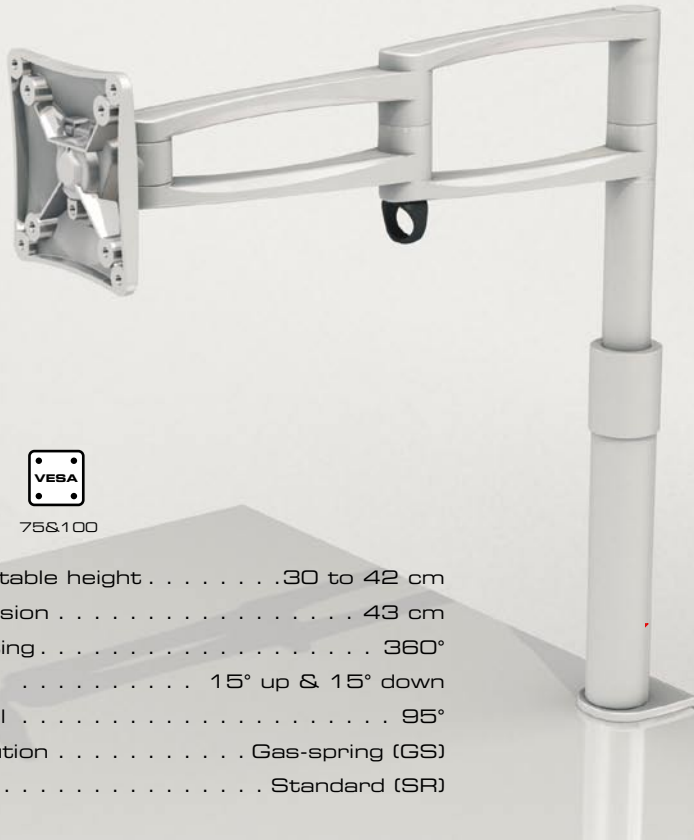

15KG



75&100

- Adjustable height . . . . .30 to 42 cm
- Extension . . . . . 43 cm
- Rotating . . . . . 360°
- Tilting . . . . . 15° up & 15° down
- Swivel . . . . . 95°
- Execution . . . . . Gas-spring (GS)
- . . . . . Standard (SR)

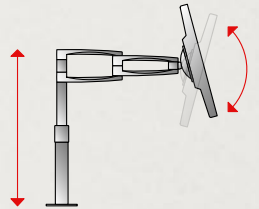

SIDEVIEW

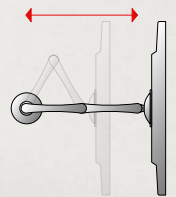

TOPVIEW

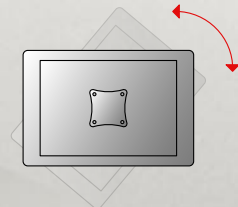

FRONTVIEW

# OFFICE LUNA 102



# OFFICE LUNA 102



15KG



75&100



26"

Distance from wall . . . . .8,8 to 44,8 cm

Rotating . . . . . 360°

Tilting . . . . . 15° up & 15° down

Swivel . . . . . 95°

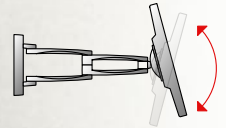

SIDEVIEW

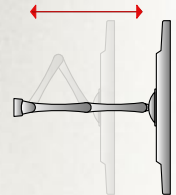

TOPVIEW

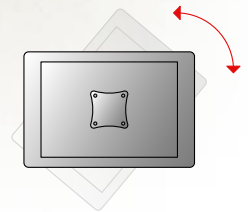

FRONTVIEW

# CEILING LUNA102



# CEILING LUNA 102

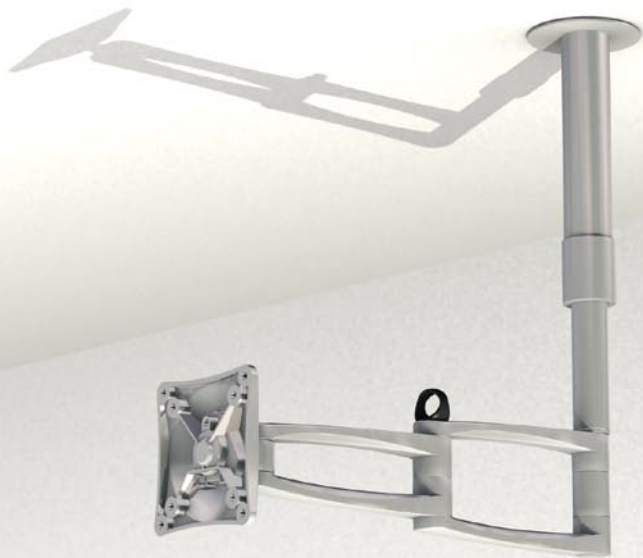

15KG



75&100



26"

- Adjustable height . . . . . 30 to 42 cm
- Extension . . . . . 43 cm
- Rotating . . . . . 360°
- Tilting . . . . . 0 to -30°
- Swivel . . . . . 95°

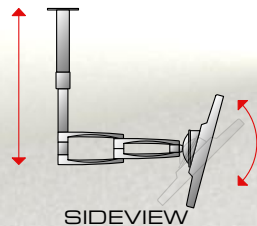

SIDEVIEW

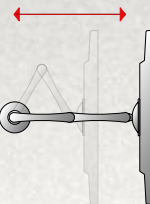

TOPVIEW

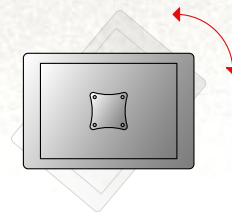

FRONTVIEW